



Pacific Premier Windows & Doors

IRON GATE/DOOR



CONTENTS

IRON GATE/DOOR



1.Production Process of Iron Door	01
2.Wrought Iron Door	05
3.Iron Interior Door	11
4.Iron Gate	17
5.Color / Glass	21
6.Handle / Lock	22

PRODUCTION PROCESS OF IRON DOOR



Cutting and Processing Materials



Forging Process



Wrought Iron Scroll Process



Immersion in Galvanizing Tank Treatment with High Temperature



Forging Process



Wrought Iron Scroll Process



Polishing Wrought Iron Door



Spray-paint Treatment



Baking Coating Treatment



Painting



11

PRODUCTION PROCESS STEPS
MAKE SURE PRODUCT QUALITY



Packing Process

WINDOW & DOOR

EXQUISITELY CRAFTING EACH DETAIL TO FORGE AN EXCEPTIONAL IRON DOOR.



Wrought Iron Door



Parts



Pacific Premier Windows & Doors

Outer frame: 50*100mm,50*150mm,60*120mm galvanized square tubing/customized dimension
Door frame: 150*50mm, 120*50mm galvanized square tubing with high temperature/customized dimension

Profile thickness:2.5/3.0mm

Door sash thickness:40mm/50mm/65mm(thermal-break door)

Door frame thickness:25mm/30mm/40mm/50mm/65mm with sealing strips, and the width can be customized according to the wall thickness.

Wrought iron scroll: 14*14mm/16*16mm solid steel/custom size

Grille: 16*16mm/20*10mm solid steel/custom size

Door trim molding: no/ single wrapping

Restricted size: single door sash, width ranging from 650mm to 1200mm, height up to 4500mm.

Frame width ranging from 250mm to 3500mm, height up to 5500mm.

Craftsmanship: customize according to styles

Glass: customizable

Rust prevention process: galvanized tubing with high heat+galvanized iron treatment for wrought iron door pattern decorations

Painting process :fluorocarbon painting series. With 1 layer primer+ high heat galvanized coating+ 2 to 3 layers finish coating

Color: customizable

Lock set: custom

Lock body: mechanical lock body/magnetic lock body/ball catch lock

Hinge: wrought iron welded hinge

Door threshold: without door sill/ the threshold with seven-character opening inward or outward

Optical hardware/accessories: weatherstrip at the door bottom/ball catch door hardware

Door opening method: open inward/outward

Installation method: expansion screw bolt/welded corner brackets/screws for fixing wooden frame

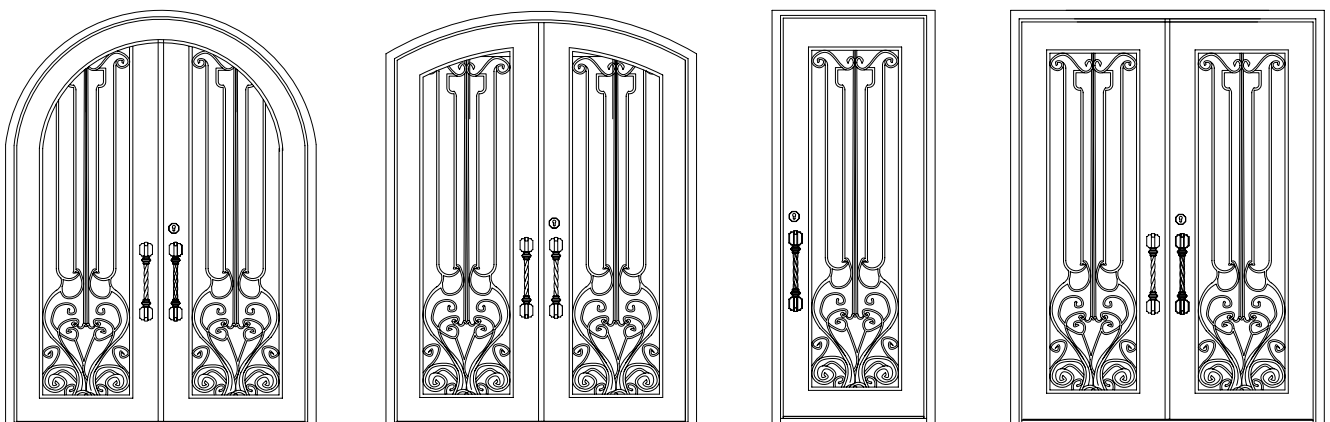

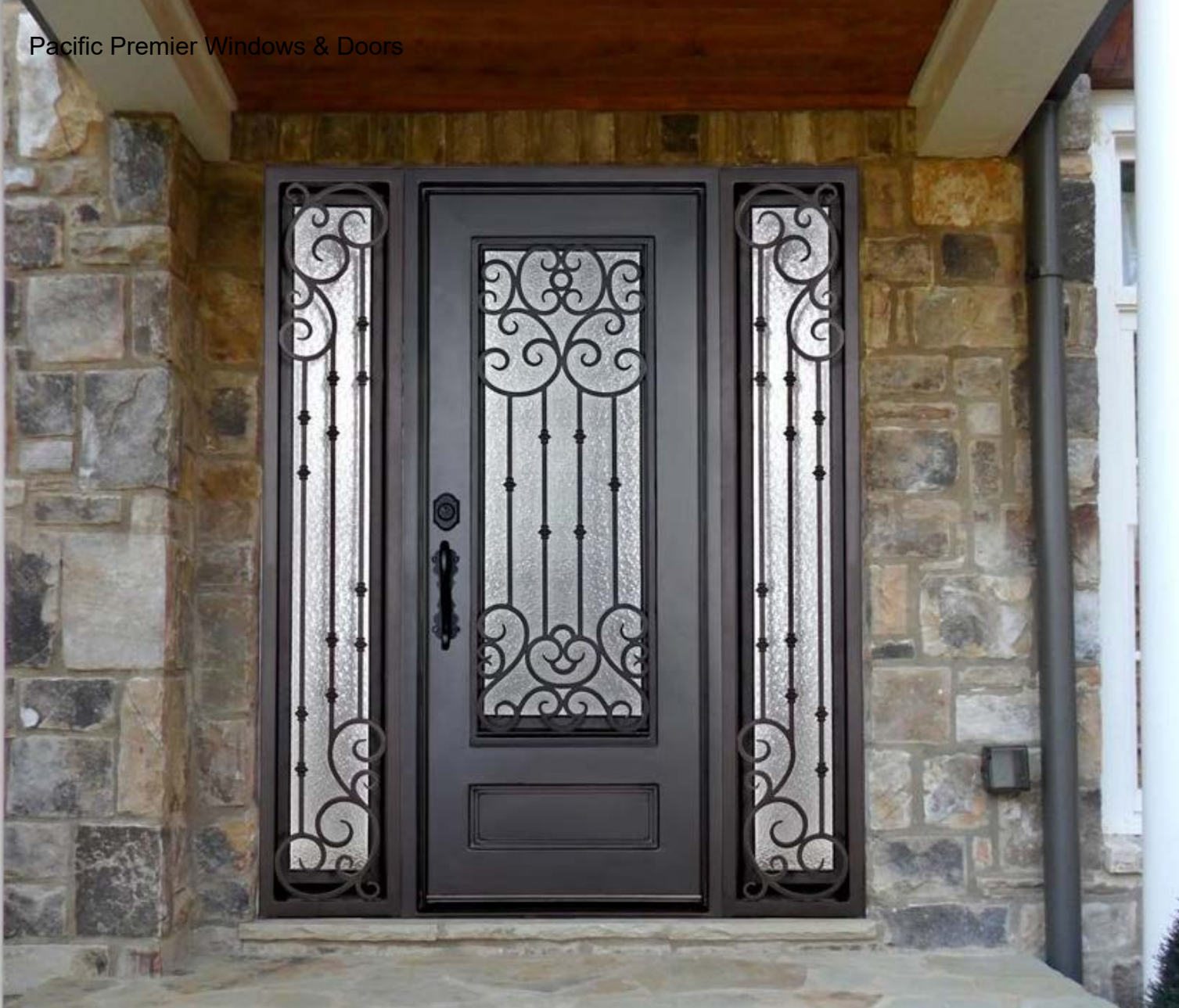

WINDOW & DOOR





WINDOW & DOOR



Iron Interior Door



Parts



Pacific Premier Windows & Doors

WINDOW & DOOR

Outer frame: 50*100mm,50*150mm,60*120mm galvanized square tubing/customized dimension
Door frame: 150*50mm, 120*50mm galvanized square tubing with high temperature/customized dimension

Profile thickness:2.5/3.0mm

Door sash thickness:40mm/50mm/65mm(thermal-break door)

Door frame thickness:25mm/30mm/40mm/50mm/65mm with sealing strips, and the width can be customized according to the wall thickness.

Wrought iron scroll: 14*14mm/16*16mm solid steel/custom size

Grille: 16*16mm/20*10mm solid steel/custom size

Door trim molding: no/ single wrapping

Restricted size: single door sash, width ranging from 650mm to 1200mm, height up to 4500mm. Frame width ranging from 250mm to 3500mm, height up to 5500mm.

Craftsmanship: customize according to styles

Glass: customizable

Rust prevention process: galvanized tubing with high heat+galvanized iron treatment for wrought iron door pattern decorations

Painting process :fluorocarbon painting series. With 1 layer primer+ high heat galvanized coating+ 2 to 3 layers finish coating

Color: customizable

Lock set: custom

Lock body: mechanical lock body/magnetic lock body/ball catch lock

Hinge: wrought iron welded hinge

Door threshold: without door sill/ the threshold with seven-character opening inward or outward

Optical hardware/accessories: weatherstrip at the door bottom/ball catch door hardware

Door opening method: open inward/outward

Installation method: expansion screw bolt/welded corner brackets/screws for fixing wooden frame

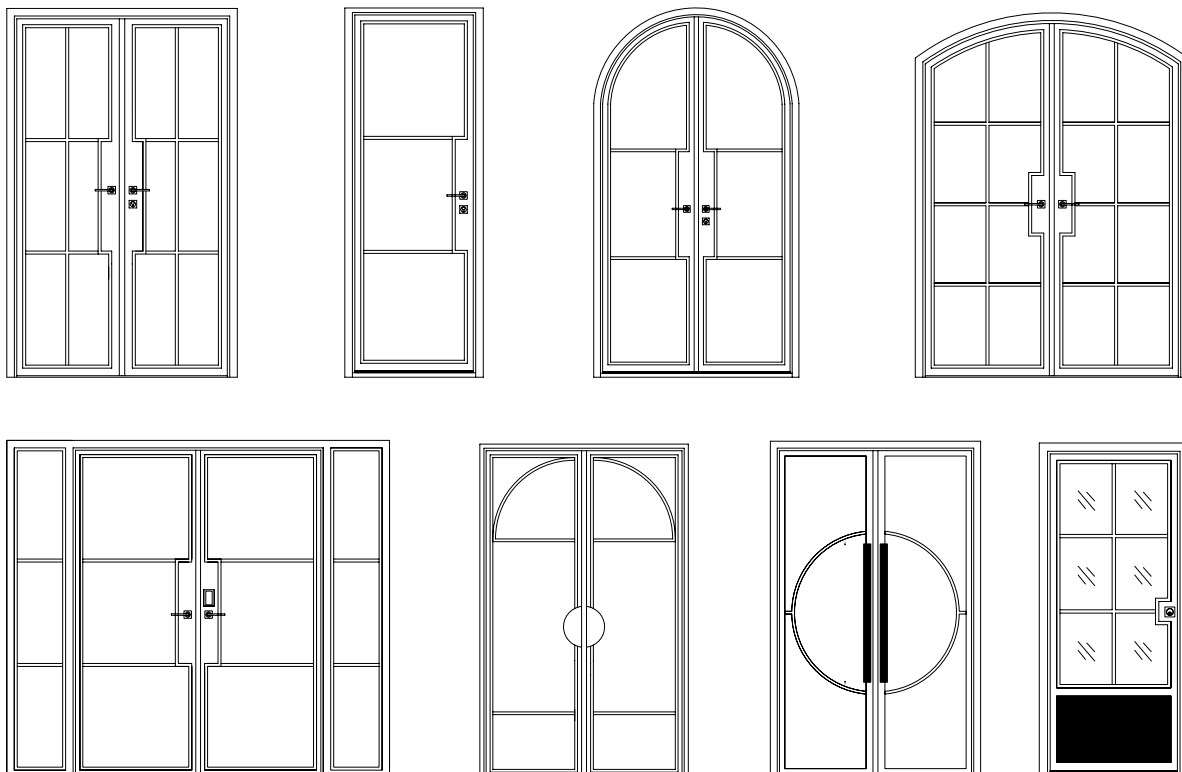

WINDOW & DOOR



WINDOW & DOOR





WINDOW & DOOR



Iron Gate



Parts



Pacific Premier Windows & Doors

Outer frame: 50*50mm,60*60mm,60*120mm galvanized square tubing/customized dimension

Profile thickness: 2.0mm/2.3mm

Door sash thickness: 40mm/50mm/60mm

Wrought iron scroll: solid steel with customized size

Grille: solid steel with customized size

Iron plate: 3mm/4mm thickness

Door trim molding: no

Restricted size: single door sash 650mm-4500mm in width, and height within 3500mm

Craftsmanship: customize according to styles

Glass: customizable

Rust prevention process: galvanized tubing with high heat + immersion in galvanizing tank treatment with high temperature

Painting process :fluorocarbon painting series. With 1 layer primer+ high heat galvanized coating+ 2 layers finish coating

Color: customizable

Lock set: custom locks/ without locks

Lock body: mechanical lock body/ without lock

Hinge: wrought iron welded hinge

Door threshold: no

Door opening method: open inward or outward/slide

Installation method: expansion screw bolt/welded corner brackets/screws for fixing wooden frame

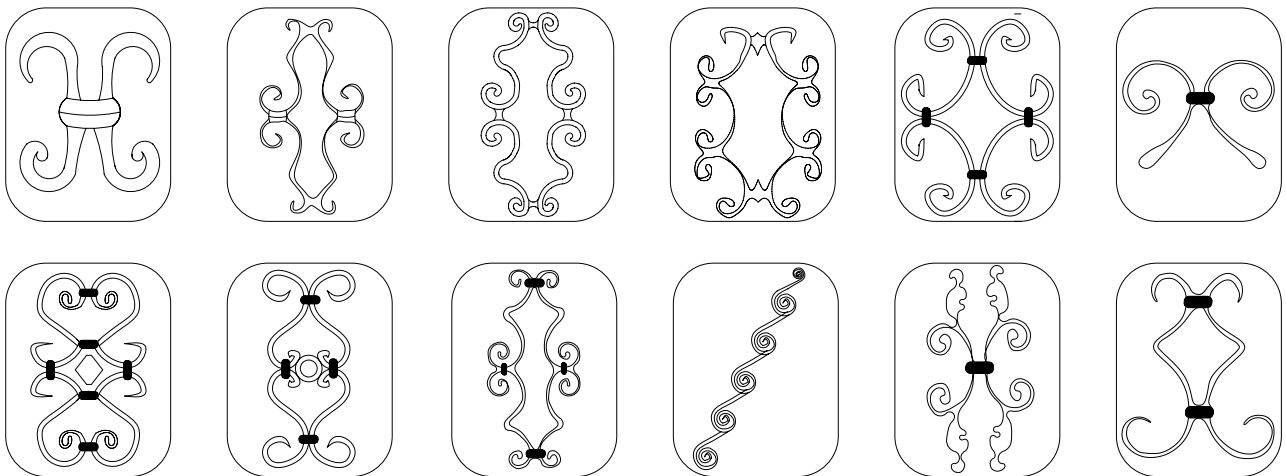





Color



IG-01



IG-02



IG-03



IG-04



IG-05



IG-06



IG-07



IG-08

Glass Type



low-E Glass

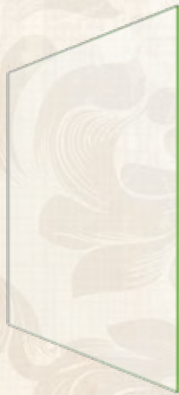

Clear Glass

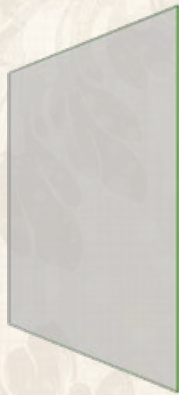

Coated Glass



laminated Glass



Insulated Glass

Glass Style

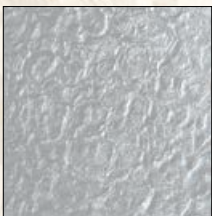

Clear Ripple Glass

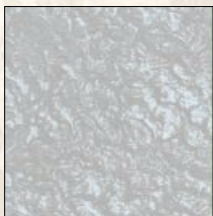

Granite Textured Glass



Rain Glas



Nashii Clear Patterned



Fluted Glass

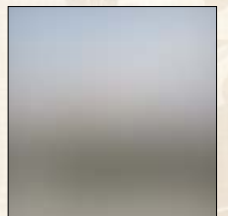

Frosted Glass

Large Handles

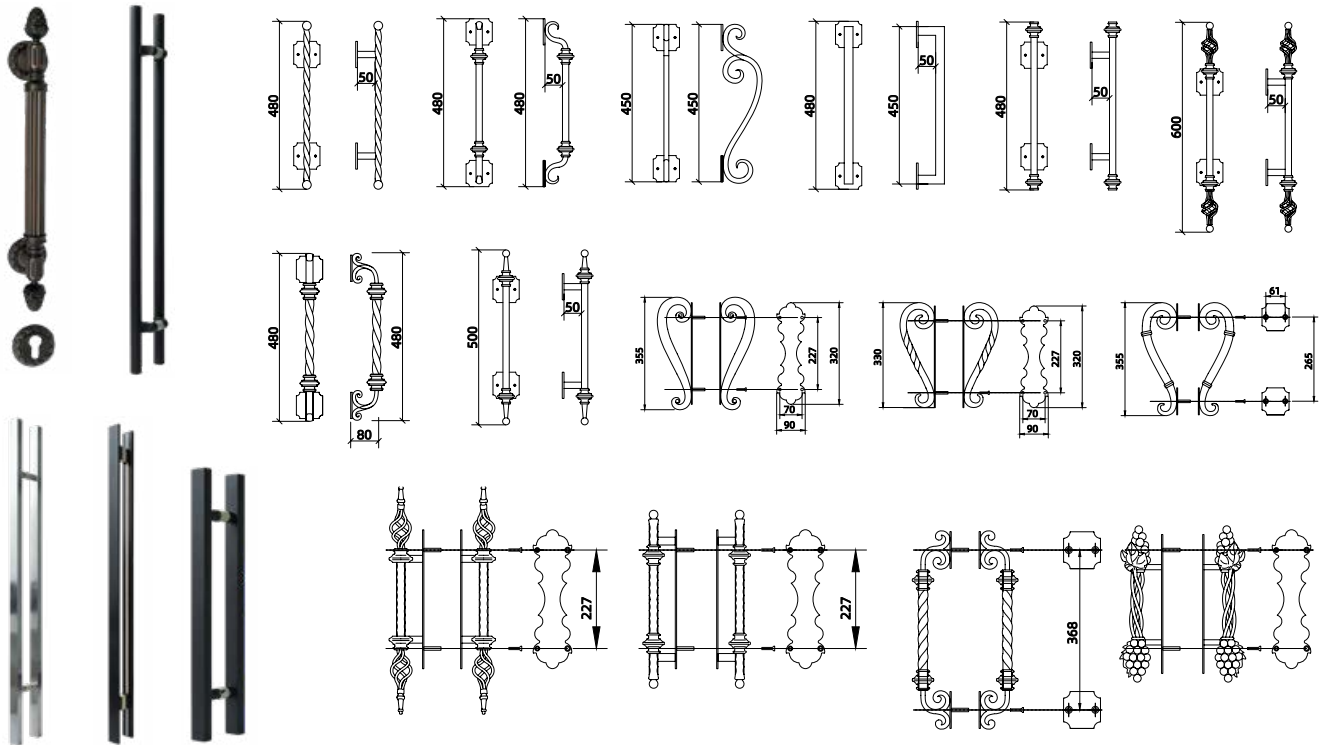

Entry Door Locks



Interior Door Locks





Pacific Premier Windows & Doors



www.pacificpremierwindows.com/